



ANYTHING ELSE IS JUST A HOT TUB





For each and every one of us life is moving at pace, and it's getting faster.

With global advancements in technology, society now harnesses a culture of needing everything instantly.

The benefits of these advancements are many and varied, indeed we as a brand are at the forefront of technological innovation within our own industry.

But a constant at the core of our values has always been and remains wellbeing, both physically and mentally.

As original pioneers of the hot tub industry, we completely understand the science behind why hydrotherapy can have such a genuine, positive impact on the way you feel.

So, whether you need a haven of peace away from the stresses of a hard day at work, or are searching for the ultimate in muscle relaxation, the following pages will guide you through how you can experience the 'Jacuzzi® difference' for yourself.

It's the best moment of the day.



J-355™



JACUZZI® BRAND IS AN ICON

Legendary for performance, reliability and ease of use, we set the standard by which all hot tubs are measured. While imitation may be the sincerest form of flattery, only 60 years of innovation can produce hot tub designs made to the demanding standards of the Jacuzzi® Brand.



Jacuzzi® Brand products are manufactured in 5 countries, enjoyed in more than 100 countries worldwide, and employ thousands of people around the world. Representing decades of innovation, design, performance and ease of use, the Jacuzzi® Brand is trusted by millions of customers globally.



Hot Tubs



Bathtubs



Showers



Swim Spas



Saunas



Commercial

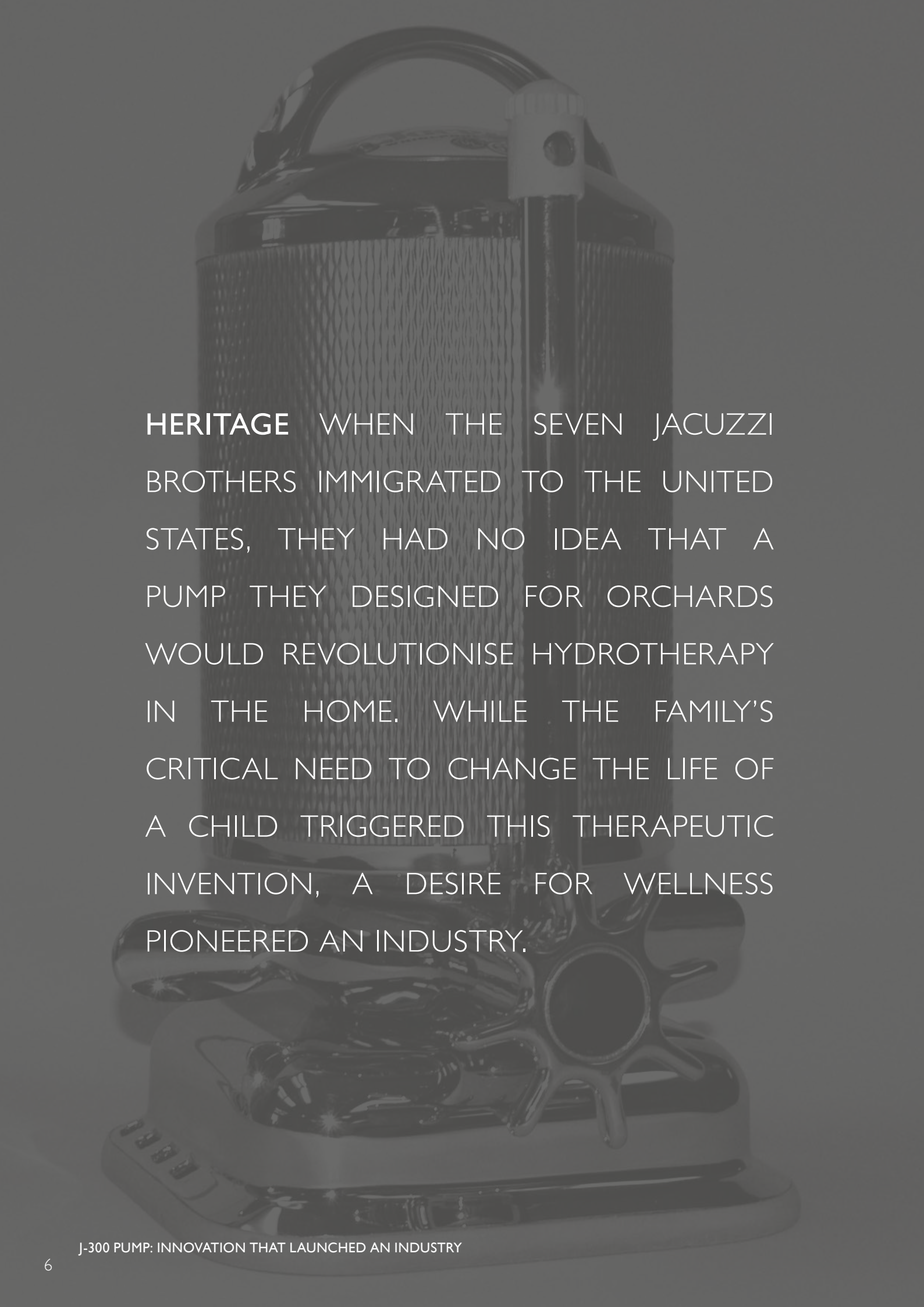

HERITAGE WHEN THE SEVEN JACUZZI BROTHERS IMMIGRATED TO THE UNITED STATES, THEY HAD NO IDEA THAT A PUMP THEY DESIGNED FOR ORCHARDS WOULD REVOLUTIONISE HYDROTHERAPY IN THE HOME. WHILE THE FAMILY'S CRITICAL NEED TO CHANGE THE LIFE OF A CHILD TRIGGERED THIS THERAPEUTIC INVENTION, A DESIRE FOR WELLNESS PIONEERED AN INDUSTRY.

THE NAME THAT LAUNCHED AN INDUSTRY CONTINUES TO REDEFINE IT

By 1920 all of the Jacuzzi Brothers had immigrated to the United States, determined to change the world with their inventions. Starting by laying roots in the aviation industry, their invention of a hydraulic aircraft pump led them to the creation of a deep well agricultural pump.

By the 1940's, 15-month-old Ken Jacuzzi was diagnosed with debilitating rheumatoid arthritis. When traveling for hydrotherapy treatments at a distant hospital began to wear on his child, Candido Jacuzzi redesigned the agricultural pump into what's known as the J-300™ hydromassage pump, turning any soaking bathtub into a relaxing and rejuvenating hydro-therapeutic spa, and allowing Ken to return to the family home.

Overwhelming demand for the hydromassage pump led to the founding of Jacuzzi® in 1956 and the whirlpool bathing category was born. Since then, the company continued to lead and grow the new industry, from integrating pumps and jets into their flagship bathtub to launching their first bath that worked both indoors and outdoors. The first to highly-engineer jets, the Jacuzzi® Brand has become synonymous with jetted hydrotherapy, well-being and performance.

With a foundation in health and wellness and a dedication to research and innovation, Jacuzzi continues to develop products that improve the lives of both high-performance athletes and everyday people while leading the industry.

KEN JACUZZI WITH FATHER, CANDIDO JACUZZI



HYDROMASSAGE

More jets do not equal a better hydromassage, but the right jets do. Jacuzzi® Brand hydromassage utilises the Aqualibrium® formula – the perfect mix of air and water – to deliver a jetted massage that reduces stress and lower back pain, improves sleep and post exercise recovery, and alleviates restless leg syndrome, cramps, arthritis and fibromyalgia, improving your overall wellbeing. As simple as enjoying a cup of coffee, a regular hydromassage routine can be more beneficial than you realise.



$$\text{BALANCE} = \left(\frac{\text{PUMP}}{\text{SEAT}} \right)$$

ANTHROPOMETRIC DIMENSIONS

By studying the anthropometric dimensions of the 5th percentile of females and 95th percentile of males, we can design hot tubs based on the average dimensions of 90% of the population to deliver a personalised massage.

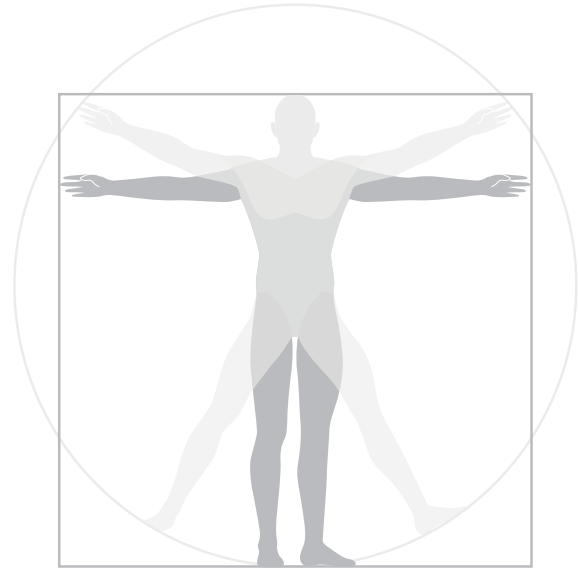

MUSCLE STRUCTURE
JET CONFIGURATION

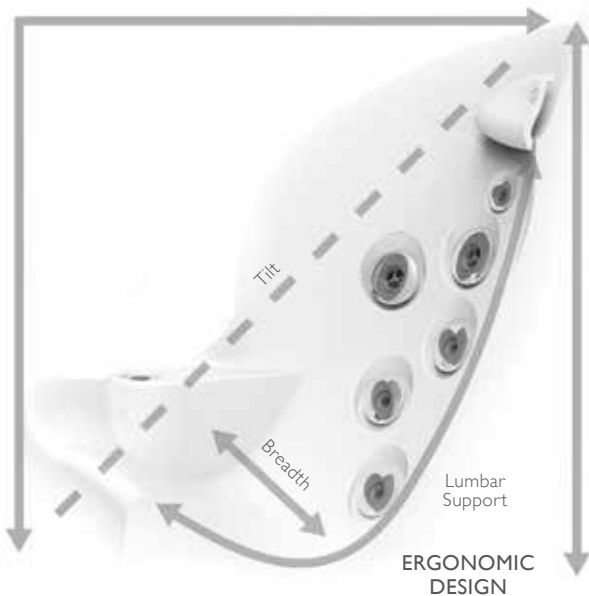

ERGONOMIC SEATING

Seats designed to follow the contours of the body and recessed jets placed to perfectly match the muscle structure of the human form delivers a comfortable, premium hydromassage experience for most body types.

COMPLETE BALANCE

Using the Aqualibrium® Formula, each jet is individually calibrated to deliver the perfect balance of air and water, then precisely paired with the exact pump-to-jet ratio needed to ensure a balanced experience in each and every seat.

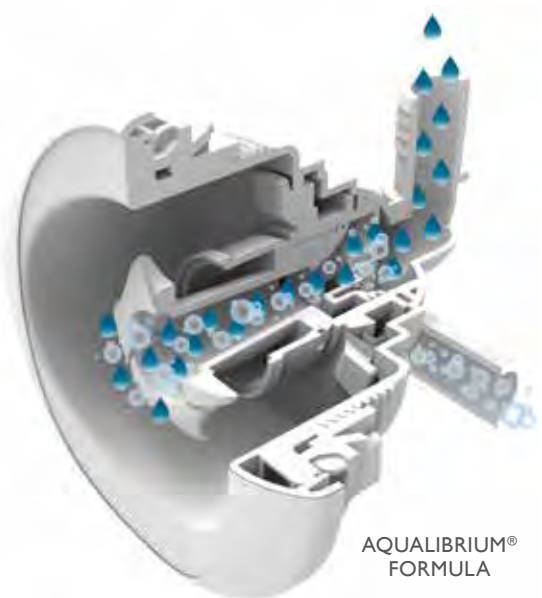

POWERPRO® JETS* COLLECTION

Our products deliver an adjustable high-flow, low-pressure hydromassage that feels like no other.



MX POWERPRO® MX

Based on the form and function of the original Jacuzzi® Jet, the MX jets deliver maximum volume at a higher air-to-water ratio to deliver a bold massage to the muscles in the lower back.



BX POWERPRO® BX

The comforting yet rejuvenating bubbling effect massages the calves.



FX-L POWERPRO®
FX LARGE

Focusing on the middle of the back to relieve tension and muscle strain, the spiral action massage promotes better circulation.



FX **FX-R** **NX2** **PX**

FX THERAPY SEAT

The full coverage neck, shoulders and back seat delivers a deep, adjustable, rifling, spiral stream of air and water to relieve chronic aches and pains.



MX **NX2**

MX JET THERAPY SEAT

Recognized as our original Jacuzzi® jet, the MX jet delivers a maximum volume, low pressure deep tissue massage for the lower back.

											
J-500™, J-400™ AND J-300™						J-300™ EXCLUSIVE	J-400™ J-300™	J-500™ J-400™	J-500™ AND J-400™		

POWERPRO® JETS COLLECTION KEY



 POWERPRO® RX

The spinning RX jet delivers comforting relief to the back and shoulders utilising the highest performance hydromassage the Jacuzzi® Brand offers.



 POWERPRO® PX

Perfect for small muscle groups in the wrists, hands and legs, the gentle pulsating massage can be adjusted for different rates of flow.



 POWERPRO® FX DIRECTIONAL

Designed to relieve tension and improve circulation, this spiral action directional jet delivers a bold, targeted massage to the hips.



RX JET THERAPY SEAT

The spinning RX Jet seat delivers comforting relief to the back and neck utilising the highest performance hydromassage the Jacuzzi® Brand offers.



PROAIR™ LOUNGE

Ease tension from your shoulders to your feet through targeted jets, pulsating FX Rotational jets, and exclusive bubbling BX jets for a full-body experience.

CLEAN WATER

Sophisticated yet simple, our water management system is designed to work alongside Jacuzzi® genuine parts for ease of use and exceptional performance. Utilising CLEARARRAY® UV-C technology, and up to five stages of water management, simply put, Jacuzzi® Brand technology makes it easy to maintain clean and clear water.

CLEARARRAY® UV-C technology uses nature inspired technology to neutralise pathogens and works with traditional chlorine or bromine sanitiser for sensitive skin. This same technology is used in bottled drinking water, aquariums and hospitals.

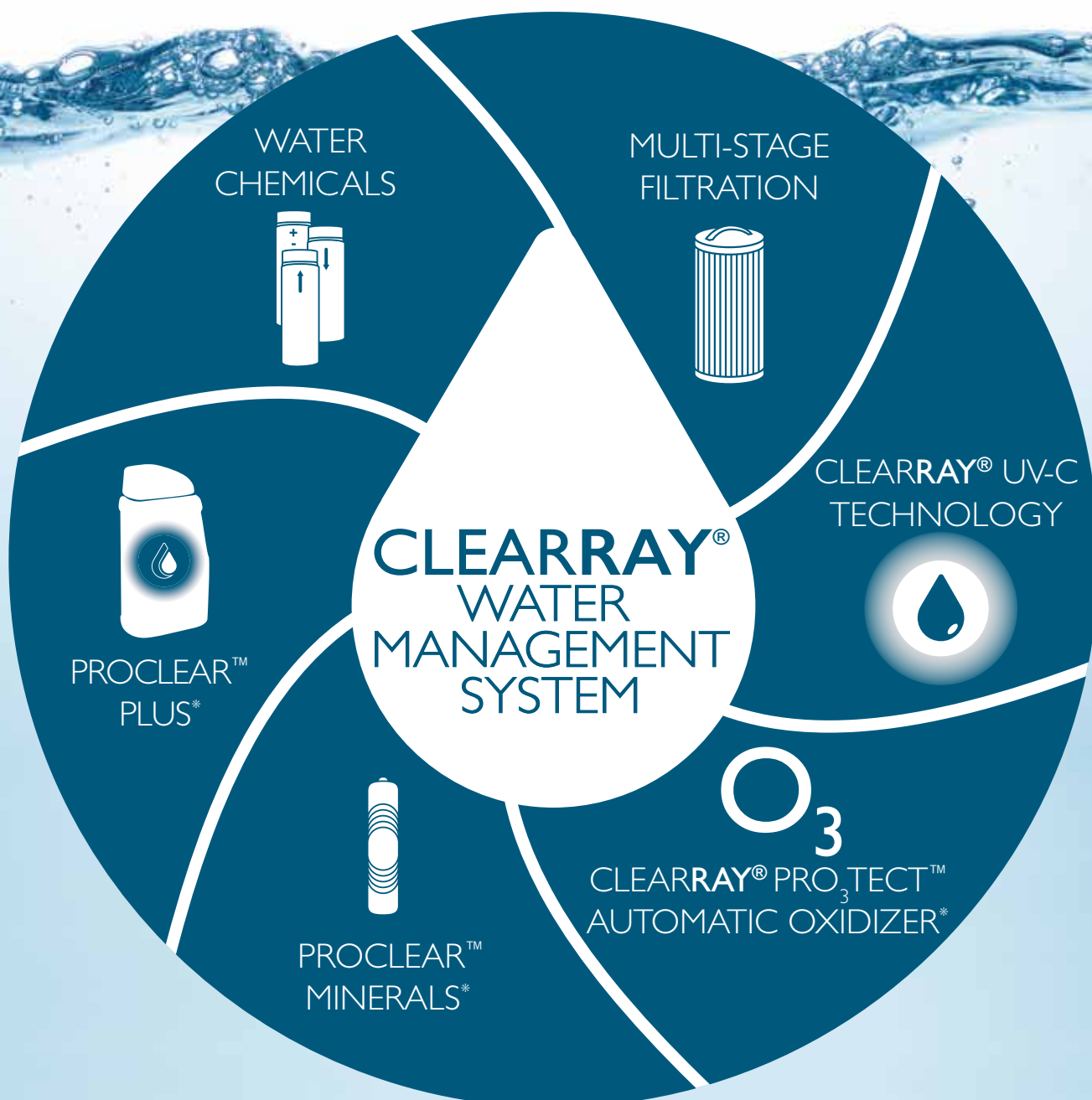

CLEARRAY®

WATER MANAGEMENT SYSTEM

INTEGRATED FEATURES ENSURE THE CLEANEST, CLEAREST WATER WITH MINIMAL EFFORT FROM YOU



WATER CHEMICALS

A complete line of water care products that support the proper foundation for balanced water



PROCLEAR™ PLUS*

Boosts performance and provides a full systems clean



PROCLEAR™ MINERALS*

Conditions water with trace elements of silver to keep your hot tub water fresh when used alongside chlorine or bromine; fits into convenient twist-off cap of filter designed to fit mineral cartridge seamlessly



MULTI-STAGE FILTRATION

Up to five stages of filtration to ensure clear water to the finest particle for clean water quickly



CLEARRAY™ UV-C TECHNOLOGY

Sanitises water with the power of nature-inspired UV-C without damaging hot tub shell or equipment



CLEARRAY® PROTECT™ AUTOMATIC OXIDIZER*

Designed to work with CLEARARRAY® UV-C technology, automatically oxidizing impurities in the water with low-output ozone

*Optional extra for some collections. Not stocked as standard on all hot tub models. Please speak to your local retailer for more information.

QUALITY

Driven by the desire to continually develop products worthy of the Jacuzzi® Brand, our engineers, designers and craftspeople never stop seeking perfection.

Everything we manufacture is designed for reliability, both inside and out. We believe that quality is only as good as the people, parts and processes behind it, which is why our products are exceptional engineered with the best materials to ensure a superior offering.

SUPERIOR PROLAST™ COVERS

Custom fit to lock in heat and improve energy efficiency and safety

POWERPRO® JETS

Hydromassage with balanced pressure for best feel

PROFUSION™ SHELL

Three layers for a strong, scratch-resistant shell



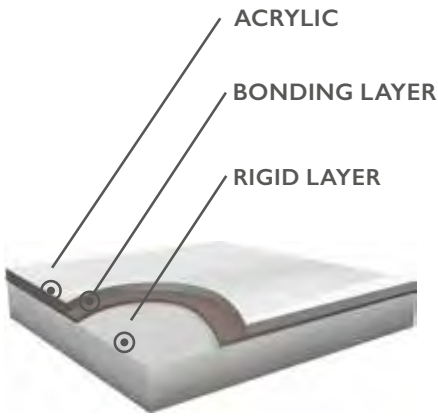

PROFUSION™ SHELL
 Three layers of material for a strong, scratch-resistant shell



FULL-FOAM INSULATION
 An air, moisture, and sound barrier adding structural integrity to pipes



POWERPRO® JETS
 Utilises the Venturi (fluid pressure) effect to create the perfect balance of air and water

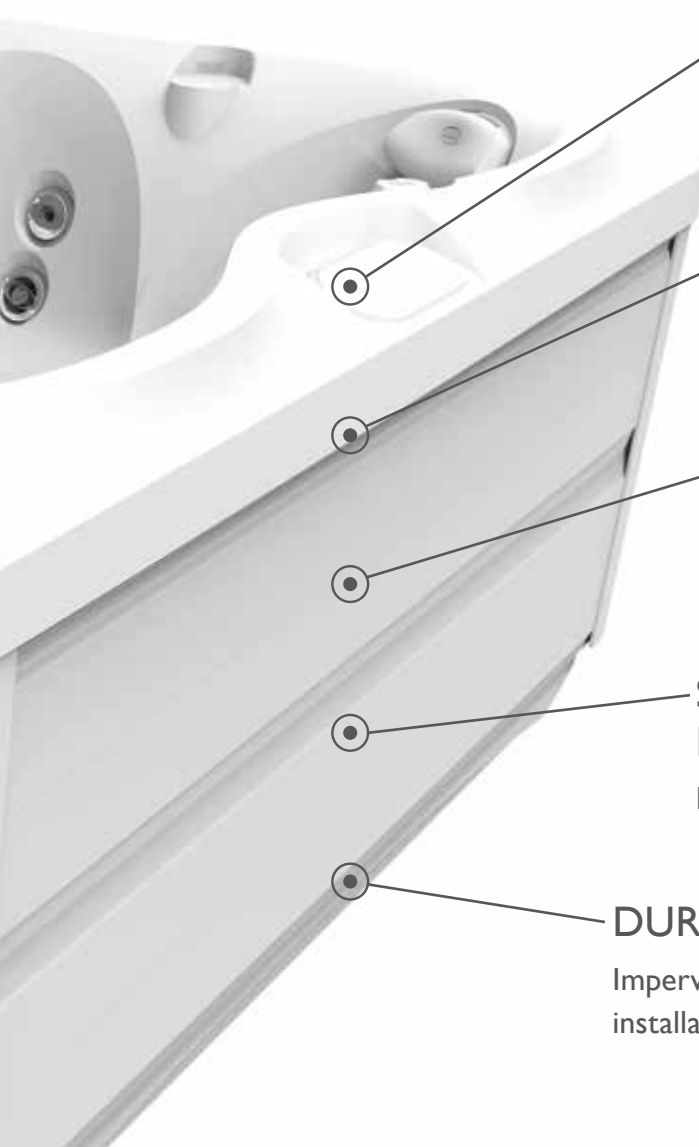

PROGRAMMABLE FILTRATION

Adjust settings based on energy usage reports in your SmartTub™ app

PERFORMANCE-ENGINEERED PLUMBING

Precise pump-to-jet ratio for optimized water pressure in every seat

TOOL-FREE CABINETRY

High quality, UV-resistant synthetic cabinetry with easy access to critical components in your hot tub

SUPPORTIVE FULL-FOAM INSULATION

Retains heat, absorbs noise, and supports plumbing

DURABLE PROPOLYMER™ BASE

Impervious to nature and moisture, and makes installation easy

INNOVATION

From an app on your smart device, you can enjoy the next generation of spa ownership thanks to Jacuzzi® Brand technology.

Our SmartTub™ system is the only app to run on a cellular platform and uses cloud integration to provide remote monitoring, sending real-time alerts, diagnostics and energy usage reports from any location. This exclusive system is engineered to maximise relaxation and recovery, making it easier than ever to use and maintain a Jacuzzi® hot tub.

“
Alexa,
ASK MY
hot tub
TO START
my massage”



The smart way to control and monitor your hot tub

SIMPLIFIED HOT TUB OWNERSHIP AT YOUR FINGERTIPS



CUSTOMISE YOUR SETTINGS

- Control energy savings and filtration
- Change temperature, lighting, and jets
- Manage your holiday home hot tub



REMOTE MONITORING

- Sends real-time alerts and diagnostics to the dealer
- Delivers energy usage reports
- Relays power outage notifications

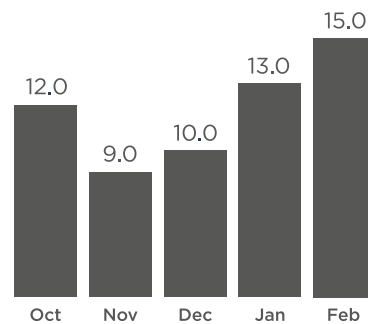

EASY TO USE

- Always connected with cellular based service
- Activate hot tub with your Smart Home device
- Access personalised tips and how-to videos

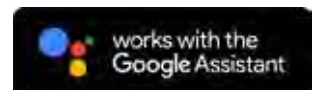

SmartTub™ system uses cellular-based communication and requires cell service from our provider partner in your area. See website for details.

*Requires subscription beginning in second year of ownership.

**Estimates are based on sensor readings and are not meant to match your utility measurements, see your local utility company for specifics to your local system.

THERE'S A JACUZZI® HOT TUB FOR EVERY KIND OF SPACE

No matter whether your space is generous, compact or somewhere in-between, there's a Jacuzzi® hot tub for every scenario. From a lawn fringed patio to a balcony or secluded garden retreat, you can be sure that our skillfully designed and east-to-install products will be right at home. Plus with no need for outdoor plumbing, your hot tub can be conveniently installed into a level area that best suits you.





J-475™



J-235™



J-365™



J-445™

CHOOSING YOUR MODEL

1. SELECT SIZE AND MASSAGE OPTIONS

A common misconception about hot tub size is that you're limited to models with less seating options when garden space is limited. The good news is that a hot tub with more massage combinations requires only a slightly larger footprint; sometimes a matter of only a few centimetres.

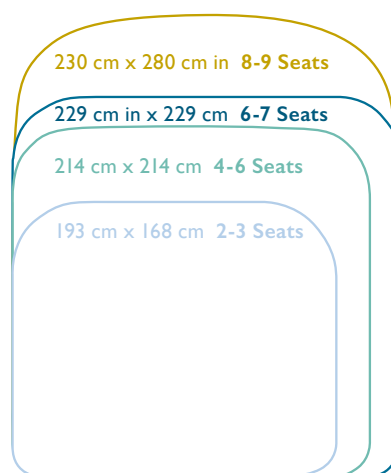

2. CHOOSE LOUNGE VS. OPEN SEATING

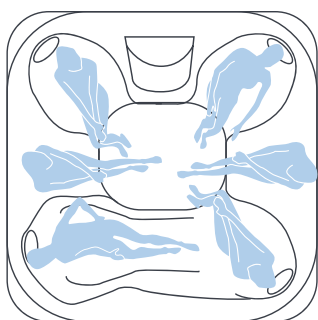

A lounge seat offers a full-body massage option and a more secluded spa experience.

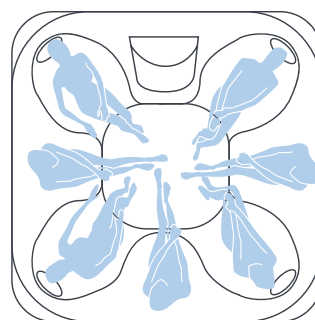

An open seating model offers more massage options and makes communicating with others in the hot tub easier.

3. FIND THE COLLECTION THAT'S RIGHT FOR YOU

J-500™ COLLECTION Revolutionary Design, Legendary Performance

J-400™ COLLECTION Elegant Styling, Superior Hydromassage

J-300™ COLLECTION Smart Engineering, Premium Jetting

J-200™ COLLECTION Quality and Value



THE J-500™

LUXURY COLLECTION

Our flagship collection combines ground-breaking design, technological innovation and the now legendary Jacuzzi® hydromassage to deliver a new standard of hot tub luxury.

BENEFITS OF THIS COLLECTION

- The unique aesthetic of **Curvalux™ Designer Woven Exterior** adds a durable, luxurious touch to your garden retreat
- **Dual Elevated Edges with Multi-Colour Waterfalls** provides the soothing sounds of two waterfalls for enhanced relaxation
- Make a statement with **Integrated Corner Exterior Lighting** in any outdoor space
- The full colour **ProTouch™ Glass Control** utilises touch screen technology for ultimate ease of use
- Our **SmartTub™ System** is the smart way to control and monitor your hot tub
- **Exclusive Patented Jet Technology** delivers the deep tissue massage you've been looking for with a variety of focussed jets
- Designed to work with **CLEARRAY® UV-C** technology, **CLEARRAY® PRO³TECT™** oxidises impurities for crystal, clean water

Plus many, many more.

Speak to your local retailer for more details or visit www.jacuzzi.co.uk

THE J-500™
LUXURY COLLECTION





J-575™



J-585™ IP

231 x 231 x 92 cm (107 cm at side)
Seating Capacity: 6-7 Total Jets: 46



J-575™ IP

231 x 231 x 92 cm (107 cm at side)
Seating Capacity: 5-6 (1 lounge) Total Jets: 49

IP - Stereo included

Images for illustration purposes only. Dimensions and specifications provided for guidance only, actual product may vary. Please speak to your local retailer for pricing or for more information.



THE J-400™

DESIGNER COLLECTION

Offering an experience of ultimate well-being through uncompromising performance, this collection delivers a truly unique hydromassage experience, complimented by Jacuzzi® technology and innovation.

BENEFITS OF THIS COLLECTION

- The **Distinct High Back Design** adds privacy and protects from the elements providing a cosy retreat no matter the weather
- Contemporary styling and a premium finish, **ProFinish™ Cabinetry** adds a modern twist to your outdoor space
- Our **SmartTub™ System** is the smart way to control and monitor your hot tub
- The full colour **ProTouch™ Control** uses touch screen technology for ease of use
- **Exclusive Patented Jet Technology** banishes aches and pains with variety of massage options that stimulate and knead key muscle groups
- Find the perfect ambiance with **Premium LED Lighting** and set the colour to your mood
- Designed to work with **CLEARRAY® UV-C** technology, **CLEARRAY® PRO³TECT™** oxidises impurities for crystal, clean water

Plus many, many more.

Speak to your local retailer for more details or visit www.jacuzzi.co.uk

THE J-400™
DESIGNER COLLECTION





J-495™ IP

229 x 279 x 104 cm (116 cm at back)
Seating Capacity: 8-9 Total Jets: 62



J-485™ IP

231 x 231 x 95 cm (111 cm at back)
Seating Capacity: 6-7 Total Jets: 49



J-475™ IP

231 x 231 x 95 cm (111 cm at back)
Seating Capacity: 6-7 (1 lounge) Total Jets: 55

IP - Stereo included

Images for illustration purposes only. Dimensions and specifications provided for guidance only, actual product may vary. Please speak to your local retailer for pricing or for more information.

THE J-400™
DESIGNER COLLECTION





J-445™ IP

213 x 213 x 91 cm (109 cm at back)
Seating Capacity: 6 Total Jets: 46



J-435™ IP

213 x 213 x 91 cm (109 cm at back)
Seating Capacity: 5 (1 lounge) Total Jets: 48



J-425™ IP

193 x 221 x 86 cm (99 cm at back)
Seating Capacity: 4-5 Total Jets: 27

IP - Stereo included.

Images for illustration purposes only. Dimensions and specifications provided for guidance only, actual product may vary.
Please speak to your local retailer for pricing or for more information.



THE J-300™

COMFORT COLLECTION

This range has been refined and enhanced to offer an improved hydromassage experience. A deeper massage is delivered by specifically targeted jets found within the Powerpro® therapy seats.

BENEFITS OF THIS COLLECTION

- **Exclusive Patented Jet Technology** includes targeted deep tissue jets for the ultimate hydromassage experience
- Enjoy subtle lighting with **ProLite™ LED Lighting** and choose your favourite colour
- A unique **Hydrosoothe™ Massage Pillow** delivers a superior head and neck massage and a soothing cascade of water
- Built for durability, the **Illuminated Control Panel** is simple and easy to use
- Contemporary styling and a premium finish, **ProFinish™ Cabinetry** adds a modern twist to your outdoor space
- Experience added relaxation with the multicoloured **Water Rainbow® Waterfall** and the comforting sounds of falling water
- **Compatible with SmartTub™ System**, the smart way to control and monitor your hot tub

Plus many, many more.

Speak to your local retailer for more details or visit www.jacuzzi.co.uk

THE J-300™
COMFORT COLLECTION



INTRODUCING THE NEW FACE OF HYDROTHERAPY

THE J-300™ COLLECTION AS YOU'VE NEVER EXPERIENCED BEFORE

Our signature J-300™ Collection has always placed comfort at its forefront, but now style also meets substance with a new and improved collection.

Showcasing premium jet technology, ergonomically designed seating and enhanced features including striking new cabinetry and a unique massage pillow, this collection offers the ultimate in Jacuzzi® Brand hydromassage.



HYDROSOOTHE™ MASSAGE PILLOW

A unique HydroSoothe™ massage pillow, delivering a superior head and neck massage and a soothing cascade of water over the neck and shoulders without splashing or spraying.



PROFINISH™ CABINETRY

The striking ProFinish™ cabinetry features contemporary styling and corner lighting for a premium finish and added safety.



EXCLUSIVE POWERPRO® BX JET

The PowerPro® BX jet is exclusive to the J-300™ Collection and creates a comforting yet rejuvenating bubbling effect that soothes and massages the calves.



SMARTTUB™ COMPATIBLE

From an app on your smart device, you can enjoy the next generation of spa ownership thanks to Jacuzzi® Brand technology. Our optional SmartTub™ system is the only app to run on a cellular platform and uses cloud integration to provide remote monitoring from any location.

THE J-300™

COMFORT COLLECTION





J-385™ IP

231 x 231 x 97 cm

Seating Capacity: 6-7 Total Jets: 49



J-375™ IP

231 x 231 x 97 cm

Seating Capacity: 6 (1 lounge) Total Jets: 50



J-365™ IP

213 x 231 x 97 cm

Seating Capacity: 6-7 Total Jets: 44

IP - Stereo included

Images for illustration purposes only. Dimensions and specifications provided for guidance only, actual product may vary. Please speak to your local retailer for pricing or for more information.

J-325™



J-355™ IP

214 x 231 x 97 cm

Seating Capacity: 5-6 (1 lounge) Total Jets: 42



J-345™ IP

214 x 214 x 92 cm

Seating Capacity: 6-7 Total Jets: 39



J-335™ IP

214 x 214 x 92 cm

Seating Capacity: 5-6 (1 lounge) Total Jets: 40



J-325™ IP

193 x 213 x 87 cm

Seating Capacity: 4-5 Total Jets: 21



J-315™ IP

193 x 168 x 81 cm

Seating Capacity: 2-3 (1 lounge) Total Jets: 21

IP - Stereo included
Images for illustration purposes only. Dimensions and specifications provided for guidance only, actual product may vary.
Please speak to your local retailer for pricing or for more information.

THE J-200™

CLASSIC COLLECTION

A choice that combines Jacuzzi® reliability, quality and value. This is without doubt a perfect introduction to the many benefits of hydrotherapy using Classic Jets, whilst remaining true to the performance and style synonymous with Jacuzzi®.

BENEFITS OF THIS COLLECTION

- Relieve the stresses of everyday life with a **Classic Jacuzzi® Hydromassage** experience
- **Ergonomic Seating** and a **Spacious Design** provides ultimate comfort as you sit back and relax
- Features a **Waterfall®** on select models and **LED Lighting** to soothe your mind and body
- Enjoy maximised running efficiency with **Full Foam Insulation**
- Enhance your wellness experience and play the perfect soundtrack with **Optional BLUEWAVE™ Stereo**
- **Compatible with SmartTub™ System**, the smart way to control and monitor your hot tub

Plus many, many more.

Speak to your local retailer for more details or visit www.jacuzzi.co.uk





J-280™ IP

229 x 229 x 93 cm

Seating Capacity: 6-7 Total Jets: 44



J-275™ IP

229 x 229 x 93 cm

Seating Capacity: 6-7 (1 lounge) Total Jets: 45



J-245™ IP

214 x 214 x 92 cm

Seating Capacity: 6-7 Total Jets: 35

IP - Stereo included

Images for illustration purposes only. Dimensions and specifications provided for guidance only, actual product may vary. Please speak to your local retailer for pricing or for more information.

J-215™

THE J-200™

CLASSIC COLLECTION





J-235™ IP

214 x 214 x 92 cm

Seating Capacity: 6 (1 lounge) Total Jets: 35



J-225™ IP

193 x 213 x 87 cm

Seating Capacity: 4-5 Total Jets: 23



J-215™ IP

193 x 168 x 81 cm

Seating Capacity: 2-3 (1 lounge) Total Jets: 19



J-210™

∅ 198 x 92 cm

Seating Capacity: 4 Total Jets: 19

IP - Stereo included.

Images for illustration purposes only. Dimensions and specifications provided for guidance only, actual product may vary.
Please speak to your local retailer for pricing or for more information.

THE WARRANTY

JACUZZI® HOT TUB PRODUCTS

Jacuzzi® hot tubs are built to the highest standard utilising over 60 years of global industry experience. In the unlikely event that you experience any problems with your hot tub, Jacuzzi Spa & Bath Ltd have you covered with the below warranty programmes which are supported by an experienced network of UK based authorised dealerships and Jacuzzi's own Engineer Team. We also have dedicated Customer Care Team on hand to contact with any questions or issues.

Warranty durations vary dependent on the product series you choose. A full breakdown of the hot tub series and warranty durations can be found below.

Please note this warranty does not apply to hot tubs purchased for a commercial setting.

JACUZZI® DOMESTIC WARRANTY

This Warranty applies to the owner of a Jacuzzi® hot tub installed after January 1st 2018 for domestic purposes in the United Kingdom.

We are Jacuzzi Spa and Bath Limited (company registered number 08295533) of Old Mill Lane, Hunslet, Leeds, LS10 1RB.

This Warranty is transferable upon the sale of a property at which the spa is located for the remainder of the warranty period set out below, to the purchaser of that property.

PRODUCT WARRANTY

If you discover a defect in your spa product we will carry out an investigation and replace any defective components free of charge during the warranty covered period. The following warranty periods apply to your spa provided that it is purchased from us or an authorised dealer:

NB – in this warranty, a year shall mean the period of 12 calendar months.

The below table demonstrates the key warranty areas offered by Jacuzzi Spa and Bath Limited as well as the different durations given dependent on hot tub model.

Warranty Area	J-500™ & J-400™	J-300™	J-200™
Shell Structure	10 Years	10 Years	5 Years
Shell Surface	7 Years	7 Years	4 Years
Equipment & Controls	4 Years	3 Years	2 Years
Plumbing Components	4 Years	3 Years	2 Years
Cabinet	5 Years	5 Years	1 Years



Below breaks down what each of the warranty area encompasses:

Shell Structure - Jacuzzi® hot tubs are warranted against water loss due to defects in the spa shell.

Shell Surface - Jacuzzi® hot tubs are warranted against blistering, cracking, or delaminating of the interior surface of the spa shell.

Equipment and Controls - Jacuzzi® hot tubs electrical equipment components – specifically limited to the pumps, heater, and control system – are warranted against malfunctions due to defects in workmanship or materials.

Plumbing Components - Jacuzzi® hot tub plumbing components are warranted against leaks due to defects in workmanship or materials.

Cabinet - Jacuzzi® hot tubs synthetic cabinets are warranted against defects in workmanship or materials.

WARRANTIES FOR OTHER COMPONENTS

- The fuses, headrests, cabinet finish and filters are warranted to be free of defects in workmanship or materials for 30 days following delivery.
- The factory installed CLEARAY® water purification system is warranted against malfunction due to defects in workmanship or materials for one year from the original date of purchase, except the UV-C bulb and quartz tube, which are warranted for ninety (90) days from the original date of installation.
- All stereo related components (receiver, speakers, subwoofer, stereo media locker, power supply, wireless remote control, etc.) are warranted against malfunction due to defects in workmanship or materials for one year from the original date of delivery.
- All other factory installed components not mentioned specifically including, but not limited to the wood frame, jets, diverter valves, LED Lighting systems, filter shield and mechanical components are warranted against malfunction due to defects in workmanship or materials for two years from the original date of purchase.

GENUINE JACUZZI® PARTS & ACCESSORIES

Genuine Jacuzzi® brand parts & accessories (Genuine Parts or Accessories) are built to our highest standards of quality, durability and performance, and they are designed to work with your spa to ensure optimal performance and function.

This Warranty is void if we or our designated representative determine that the spa has been subjected to damage or failure due to the installation of parts and/or accessories that are not Genuine Parts or Accessories.

This disclaimer includes, but is not limited to filters, UV-C bulbs, ozone systems, repair parts and other accessories.

REGISTRATION AND NOTIFICATION

Please register your new spa within 7 days of delivery. You can register your new spa by signing up to our Jacuzzi® Club at www.jacuzzi.co.uk.

Hot tubs must be registered before any authorized service work can be performed.

To obtain service in the event of a defect covered by this Warranty, you should notify us either in writing or by telephone to the number below, or to your dealer, as soon as possible upon becoming aware that a fault has arisen. Upon proof of purchase, a designated service representative will correct the defect subject to the terms and conditions contained in this Warranty.

Upon becoming aware of a fault with your spa you should take all reasonable steps to ensure that no further damage is caused to it, for example by ceasing to use the stereo system or other component system (as appropriate), or the spa itself, until such a time as we or our authorised dealer are able to repair the fault.

There will be no charge for parts or labour to repair a defect with the spa. You are required to provide clear and uninterrupted access to the spa to enable the defect to be repaired. If we are unable to access the spa when attending a repair we may refuse to carry out the repair until such a time as access is provided; in these circumstances we may charge you for our reasonable travel and any other expenses incurred in attending at your property.

In the event that the spa is removed to a repair facility for repair and reinstalled, the cost of removal and reinstallation will be at our expense or that of our authorised dealer.

We reserve the right, at our sole discretion, to either repair or replace any spa (or part of it) that is the subject of this Warranty. In the event that we choose to provide a replacement spa, it will be at least of an equal value and specification to that which is replaced. In such an event, reasonable costs for removal of the original spa, shipping costs from the factory for the replacement spa and delivery and installation of the replacement will be our responsibility.

Any replacement part or spa will carry the balance of the original spa's warranty. Spa covers are not included.

WARRANTY LIMITATIONS

The product guarantee is only valid for products used in the United Kingdom and installed in a domestic environment. This Warranty is void where defects occur from:

- general wear and tear, or alteration;
- repair by a person not authorised by us or our authorised dealer;
- misuse or negligent use which include any installation, operation or maintenance of the spa other than in accordance with the instructions contained in the owner's manual provided with the spa, including but not limited to the failure to maintain proper water chemistry and chemical balance and the use of abrasive or improper cleaners or parts which are not Genuine Parts and Accessories;
- damage arising in transit by a carrier that is not provided by us or our authorised dealer
- the commercial use of the products.

Some parts of the spa are manufactured from natural materials (or man made materials replicating natural materials) which may change in the ordinary course of their lifespan; this may affect the look and feel of the spa. As such these are not regarded as defects, and include (without limitation):

- Products that have yellowed or changed colour in sunlight;
- Products that have failed as a result of the ingress of moisture that are typical as a consequence of use.

This Warranty does not provide cover for insulating covers, or any item attached to or installed on the spa by you.

You accept liability for repair work performed by anyone other than by us or our representative.

THIS WARRANTY DOES NOT AFFECT YOUR STATUTORY RIGHTS

ELITE PERFORMANCE PARTNERS

Jacuzzi® premium products support the needs of high endurance athletes and weekend warriors alike who are committed to maintaining and improving their quality of life through the power of hydrotherapy. By harnessing water's natural ability to heal mind, body and soul, Jacuzzi® products increase an athlete's ability to relax and recover quickly.

The Jacuzzi® Brand proudly partners with athletes and professional teams around the world, working with notable Brand Ambassadors and Performance Partners who attest to the benefits of hydrotherapy after a demanding day or training session.



JANET EVANS
Olympian and World Cup Champion Freestyle Swimmer



MIKE ERUZIONE
Captain of the Gold Medal-Winning 1980 Winter Olympic Hockey Team



AMY PURDY
Paralympic Snowboarder



TRACE WORTHINGTON
2X Olympian and U.S. Ski and Snowboard Hall of Famer



MELISSA STOCKWELL
Paralympian and Former U.S. Army Officer



JOEY MANTIA
Olympian and World Champion Speed Skater



SALLY GUNNELL
Olympic Track Champion



THURL BAILEY
Retired NBA Player and Inspirational Speaker



STEVE NYMAN
Olympian and World Cup Ski Racer



TIM JITLOFF
2X Olympian and U.S. Ski Team Member



KIMBERLEY MORRISON
Triathlete and Ironman Champion



JASON LINDSAY
Professional Trainer



CYDNEY CLANTON
LPGA Pro



Ed Baxter
Team GB Swimmer



Tim Shuttleworth
Olympian and Team GB Swimmer





TRAIN LIKE A PRO



#jacuzziperformance

SPECIFICATION CHART

J-500™ COLLECTION



J-585™

6-7 Seats

DIMENSIONS*

231 cm x 231 cm x 95 cm - 107 cm sides

DRY WEIGHT

407 kg

TOTAL FILLED WEIGHT

2,451 kg

AVERAGE SPA VOLUME

1,666 liters

ELECTRICAL

32Amps / 40Amps

MASSAGE TYPE

PowerPro

NUMBER OF PUMPS

2 x Jet Pumps, 1 x Circulation Pump



J-575™



5-6 Seats

DIMENSIONS*

231 cm x 231 cm x 92 cm - 107 cm sides

DRY WEIGHT

407 kg

TOTAL FILLED WEIGHT

2,470 kg

AVERAGE SPA VOLUME

1,685 liters

ELECTRICAL

32Amps / 40Amps

MASSAGE TYPE

PowerPro

NUMBER OF PUMPS

2 x Jet Pumps, 1 x Circulation Pump



J-400™ COLLECTION



J-495™

8 - 9 Seats
DIMENSIONS*
 229 cm x 279 cm x 104 cm - 116 cm back
DRY WEIGHT
 517 kg.
TOTAL FILLED WEIGHT
 2,862 kg
AVERAGE SPA VOLUME
 1,968 liters
ELECTRICAL
 32Amps / 40Amps
MASSAGE TYPE
 PowerPro
NUMBER OF PUMPS
 3 x Jet Pumps, 1 x Circulation Pump



J-485™

6 - 7 Seats
DIMENSIONS*
 231 cm x 231 cm x 95 cm - 111 cm back
DRY WEIGHT
 415.5 kg
TOTAL FILLED WEIGHT
 2,420 kg
AVERAGE SPA VOLUME
 1,666 liters
ELECTRICAL
 32Amps / 40Amps
MASSAGE TYPE
 PowerPro
NUMBER OF PUMPS
 2 x Jet Pumps, 1 x Circulation Pump



J-475™



6-7 Seats
DIMENSIONS*
 231 cm x 231 cm x 95 cm - 111 cm back
DRY WEIGHT
 419.5 kg
TOTAL FILLED WEIGHT
 2,444 kg
AVERAGE SPA VOLUME
 1,666 liters
ELECTRICAL
 32Amps / 40Amps
MASSAGE TYPE
 PowerPro
NUMBER OF PUMPS
 2 x Jet Pumps, 1 x Circulation Pump



J-445™

6 Seats
DIMENSIONS*
 213 cm x 213 cm x 91 cm - 109 cm back
DRY WEIGHT
 281 kg
TOTAL FILLED WEIGHT
 1,996 kg
AVERAGE SPA VOLUME
 1,401 liters
ELECTRICAL
 32Amps / 40Amps
MASSAGE TYPE
 PowerPro
NUMBER OF PUMPS
 2 x Jet Pumps, 1 x Circulation Pump



J-435™



5 - 6 Seats
DIMENSIONS*
 213 cm x 213 cm x 91 cm - 109 cm back
DRY WEIGHT
 373 kg
TOTAL FILLED WEIGHT
 2,037 kg
AVERAGE SPA VOLUME
 1,363 liters
ELECTRICAL
 32Amps / 40Amps
MASSAGE TYPE
 PowerPro
NUMBER OF PUMPS
 2 x Jet Pumps, 1 x Circulation Pump



J-425™

4 - 5 Seats
DIMENSIONS*
 193 cm x 221 cm x 86 cm - 99 cm back
DRY WEIGHT
 361 kg
TOTAL FILLED WEIGHT
 1,988 kg
AVERAGE SPA VOLUME
 1,287 liters
ELECTRICAL
 32Amps / 40Amps
MASSAGE TYPE
 PowerPro
NUMBER OF PUMPS
 2 x Jet Pumps, 1 x Circulation Pump

*All hot tub dimensions are shown in: L x W x H. All hot tub electrical requirements are 240 volts 50 hertz.

Images for illustration purposes only.

Dimensions and specifications provided for guidance only, actual product may vary.
 Please speak to your local retailer for more information.

SPECIFICATION CHART

J-300™ COLLECTION



J-385™

6 - 7 Seats
DIMENSIONS*
 231 cm x 231 cm x 97 cm
DRY WEIGHT
 415 kg
TOTAL FILLED WEIGHT
 2,610 kg
AVERAGE SPA VOLUME
 1,893 liters
ELECTRICAL
 32Amps / 40Amps
MASSAGE TYPE
 PowerPro
NUMBER OF PUMPS
 2 x Jet Pumps, 1 x Circulation Pump



J-375™



5 - 6 Seats
DIMENSIONS*
 231 cm x 231 cm x 97 cm
DRY WEIGHT
 407 kg
TOTAL FILLED WEIGHT
 2,601 kg
AVERAGE SPA VOLUME
 1,779 liters
ELECTRICAL
 32Amps / 40Amps
MASSAGE TYPE
 PowerPro
NUMBER OF PUMPS
 2 x Jet Pumps, 1 x Circulation Pump



J-365™

6 - 7 Seats
DIMENSIONS*
 214 cm x 231 cm x 97 cm
DRY WEIGHT
 394 kg
TOTAL FILLED WEIGHT
 2,285 kg
AVERAGE SPA VOLUME
 1,666 liters
ELECTRICAL
 32Amps / 40Amps
MASSAGE TYPE
 PowerPro
NUMBER OF PUMPS
 2 x Jet Pumps, 1 x Circulation Pump



J-355™



5 - 6 Seats
DIMENSIONS*
 214 cm x 231 cm x 97 cm
DRY WEIGHT
 379 kg
TOTAL FILLED WEIGHT
 2,233 kg
AVERAGE SPA VOLUME
 1,514 liters
ELECTRICAL
 32Amps / 40Amps
MASSAGE TYPE
 PowerPro
NUMBER OF PUMPS
 2 x Jet Pumps, 1 x Circulation Pump



J-345™

6 - 7 Seats
DIMENSIONS*
 214 cm x 214 cm x 92 cm
DRY WEIGHT
 374 kg
TOTAL FILLED WEIGHT
 2,114 kg
AVERAGE SPA VOLUME
 1,401 liters
ELECTRICAL
 32Amps / 40Amps
MASSAGE TYPE
 PowerPro
NUMBER OF PUMPS
 2 x Jet Pumps, 1 x Circulation Pump



J-335™



5 - 6 Seats
DIMENSIONS*
 214 cm x 214 cm x 92 cm
DRY WEIGHT
 342 kg
TOTAL FILLED WEIGHT
 2,044 kg
AVERAGE SPA VOLUME
 1,363 liters
ELECTRICAL
 32Amps / 40Amps
MASSAGE TYPE
 PowerPro
NUMBER OF PUMPS
 2 x Jet Pumps, 1 x Circulation Pump



J-325™

4 - 5 Seats
DIMENSIONS*
 193 cm x 214 cm x 87 cm
DRY WEIGHT
 312 kg
TOTAL FILLED WEIGHT
 1,976 kg
AVERAGE SPA VOLUME
 1,363 liters
ELECTRICAL
 20Amps / 32Amps
MASSAGE TYPE
 PowerPro
NUMBER OF PUMPS
 1 x Jet Pump, 1 x Circulation Pump



J-315™



2 - 3 Seats
DIMENSIONS*
 193 cm x 168 cm x 81 cm
DRY WEIGHT
 259 kg
TOTAL FILLED WEIGHT
 1,318 kg
AVERAGE SPA VOLUME
 871 liters
ELECTRICAL
 20Amps / 32Amps
MASSAGE TYPE
 PowerPro
NUMBER OF PUMPS
 1 x Jet Pump, 1 x Circulation Pump

J-200™ COLLECTION



J-280™

6 - 7 Seats
TOTAL JETS
 44 Classic Jets
DIMENSIONS*
 229 cm x 229 cm x 94 cm
DRY WEIGHT
 401 kg
TOTAL FILLED WEIGHT
 2,558 kg
AVERAGE SPA VOLUME
 1,741 liters
ELECTRICAL
 32Amps / 40Amps
MASSAGE TYPE
 Classic
NUMBER OF PUMPS
 2 x Jet Pumps



J-275™



6 Seats
TOTAL JETS
 45 Classic Jets
DIMENSIONS*
 229 cm x 229 cm x 94 cm
DRY WEIGHT
 366 kg
TOTAL FILLED WEIGHT
 2,371 kg
AVERAGE SPA VOLUME
 1,741 liters
ELECTRICAL
 32Amps / 40Amps
MASSAGE TYPE
 Classic
NUMBER OF PUMPS
 2 x Jet Pumps



J-245™

6 - 7 Seats
TOTAL JETS
 35 Classic Jets
DIMENSIONS*
 214 cm x 214 cm x 92 cm
DRY WEIGHT
 375 kg
TOTAL FILLED WEIGHT
 2,153 kg
AVERAGE SPA VOLUME
 1,363 liters
ELECTRICAL
 32Amps / 40Amps
MASSAGE TYPE
 Classic
NUMBER OF PUMPS
 2 x Jet Pumps



J-235™



6 Seats
TOTAL JETS
 35 Classic Jets
DIMENSIONS*
 214 cm x 214 cm x 92 cm
DRY WEIGHT
 347 kg
TOTAL FILLED WEIGHT
 2,050 kg
AVERAGE SPA VOLUME
 1,325 liters
ELECTRICAL
 32Amps / 40Amps
MASSAGE TYPE
 Classic
NUMBER OF PUMPS
 2 x Jet Pumps



J-225™

4 - 5 Seats
TOTAL JETS
 23 Classic Jets
DIMENSIONS*
 193 cm x 213 cm x 87 cm
DRY WEIGHT
 255 kg
TOTAL FILLED WEIGHT
 1,914 kg
AVERAGE SPA VOLUME
 1,340 liters
ELECTRICAL
 20Amps / 32Amps
MASSAGE TYPE
 Classic
NUMBER OF PUMPS
 1 x Jet Pump



J-215™



2 - 3 Seats
TOTAL JETS
 19 Classic Jets
DIMENSIONS*
 193 cm x 168 cm x 81 cm
DRY WEIGHT
 223 kg
TOTAL FILLED WEIGHT
 1,261 kg
AVERAGE SPA VOLUME
 833 liters
ELECTRICAL
 20Amps / 32Amps
MASSAGE TYPE
 Classic
NUMBER OF PUMPS
 1 x Jet Pump



J-210™

4 - 5 Seats
TOTAL JETS
 19 Classic Jets
DIMENSIONS*
 198 cm x 91 cm
DRY WEIGHT
 239 kg
TOTAL FILLED WEIGHT
 1,412 kg
AVERAGE SPA VOLUME
 908 liters
ELECTRICAL
 20Amps / 32Amps
MASSAGE TYPE
 Classic
NUMBER OF PUMPS
 1 x Jet Pump

*All hot tub dimensions are shown in: L x W x H.
 All hot tub electrical requirements are 240 volts 50 hertz.
 Images for illustration purposes only.
 Dimensions and specifications provided for guidance only, actual product may vary.
 Please speak to your local retailer for more information.

SHELL COLOURS

Once you've chosen a hot tub to suit your needs perfectly, you can finish the shell in a wide range of colours and materials. Ensuring your hot tub is everything you need in style, design and performance.

J-500™, J-400™, J-300™ & J-200™* COLLECTIONS

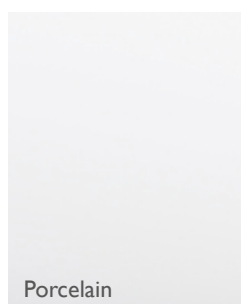

CABINET FINISHINGS

CURVALUX™ (J-500™ COLLECTION*)

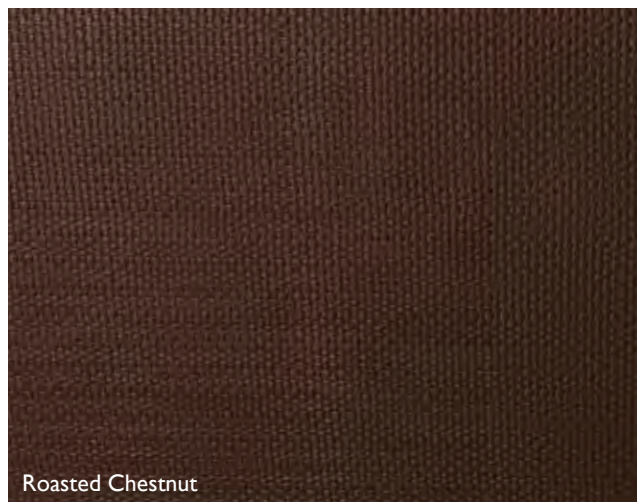

EXCLUSIVE PROFINISH™ (J-400™ & J-300™ COLLECTIONS*)

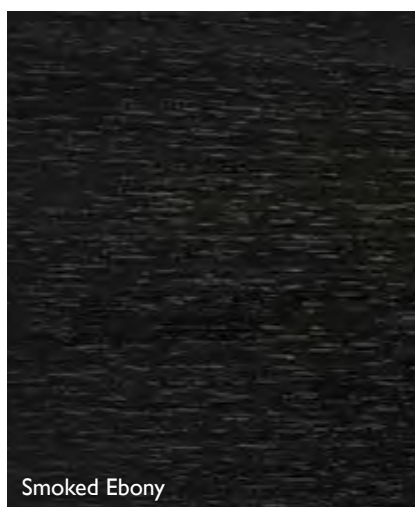

SYNTHETIC WOOD (J-200™ COLLECTION*)

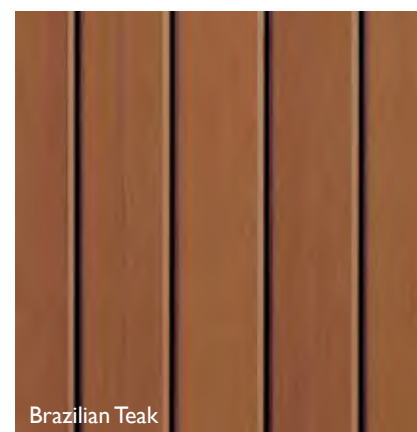
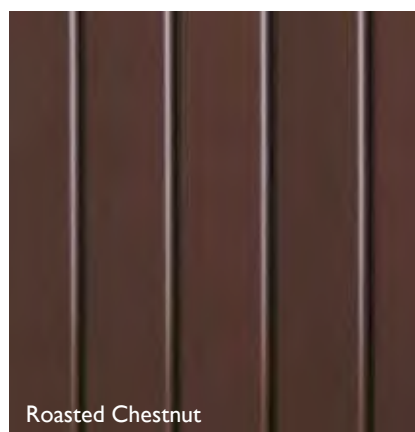

*Colour options may vary by model and may not be an exact match to colour swatches shown, please speak to your local retailer for more information.

THE BEST MOMENT OF THE NIGHT

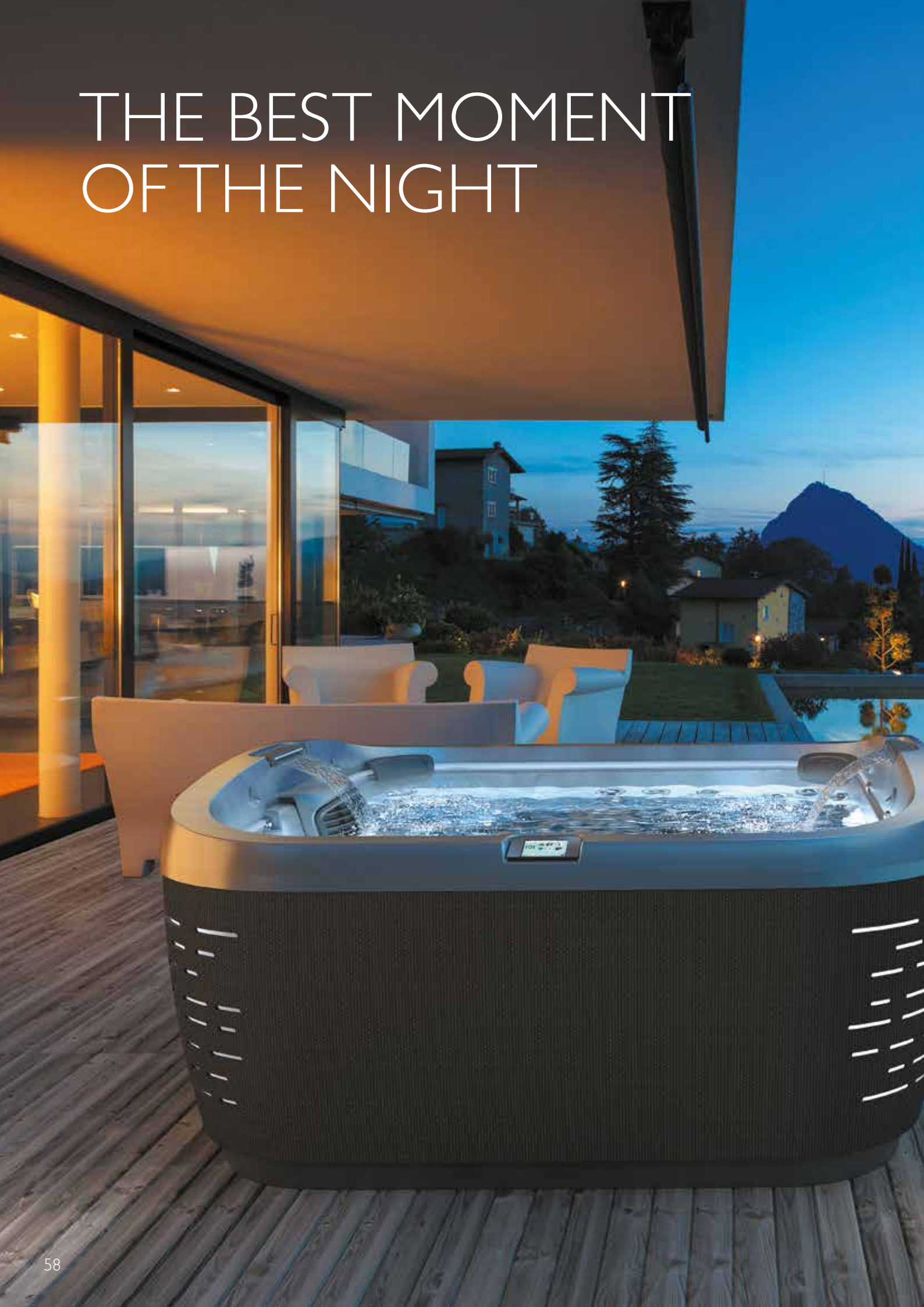



J-585™

Whether you're watching a beautiful sunset in the late summer evening, or staring up at a crystal clear moonlit sky in the dead of winter, reserve yourself the best seat in the garden with Jacuzzi®.

The relaxing and restorative effects of your hydromassage reach new heights in the evenings, treat yourself to the best night in you can experience at home.

So – set your mood lighting, choose your soundtrack, then lie back and let the strains of the day melt away in your very own Jacuzzi® hot tub...

It's the best moment of the night.

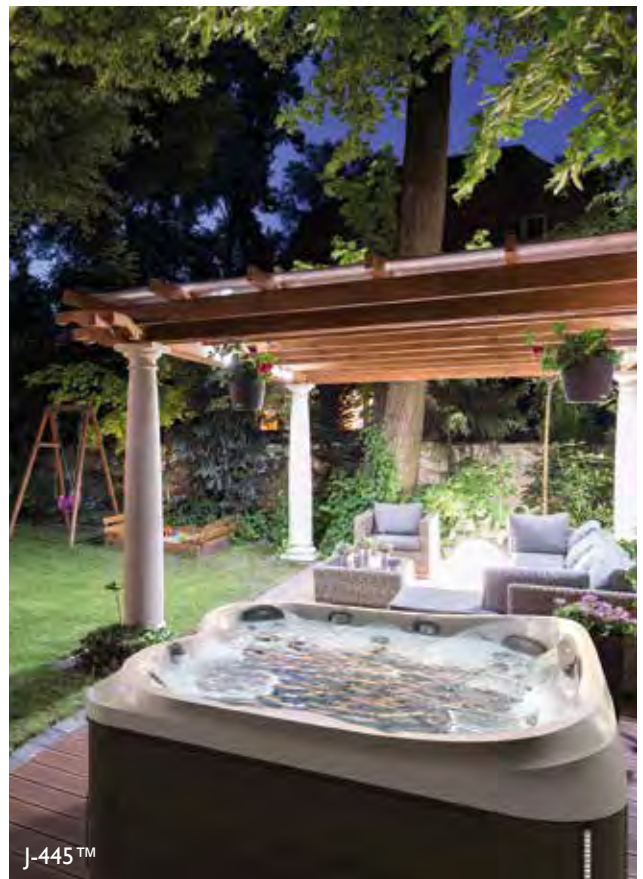

J-445™